



# Legacy<sup>®</sup> POOLS

**UNIQUE  
OVALS**



**TRUE  
CIRCLES**



**TRADITIONAL  
RECTANGLES**



## Tips

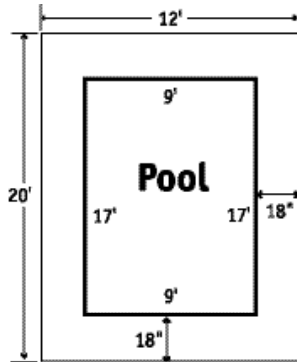

### A): POOL SIZE / SPACE REQUIRED

It is recommended to allow an additional 18" of space around the perimeter of your portable pool. For example: a 9' x 17' rectangle pool should have an area of 12' x 20'. The larger dimension (12' x 20') is referred to as a "Foot Print". For the Legacy Circles, the "Foot Print" is approximately one foot larger than the actual size of the pool, due to the low profile of the framework. A 17' Legacy Circle would need an 18' "Foot Print".

### B): HOW DO I FIND LEVEL?

It is important that your pool be placed on level ground. Though your pool can tolerate being slightly out of level, it is best for proper filtration, as well as visual concern, to have your pool as level as possible. Here is a simple way how to find level ground.

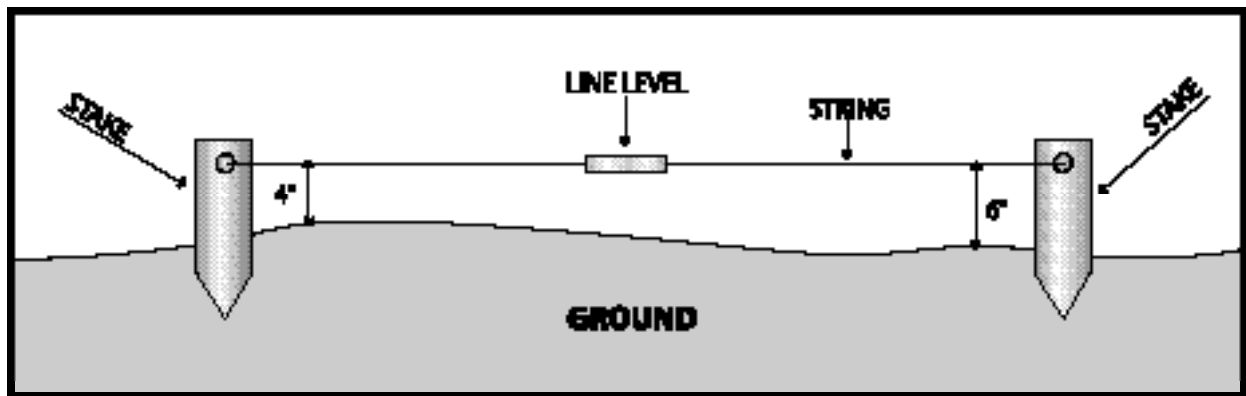

You will need:

- **Two** small wooden stakes
  - Length of string, two feet longer than longest dimension of pool
  - **One** "Line Level" (Can be purchased @ any hardware store for about \$1.50)
1. Simply set one stake into the ground at one end of where the pool will be, and the other stake at the other end.
  2. Tie the string stretched between both stakes, making sure it is stretched tight.
  3. Now set the line level in approximately the center of the string.
  4. Tap either stake further into the ground until the line level is reads "Level".
  5. Now measure the distance from the ground to the string at both ends.  
If one measurement is 4" at one stake, and 6" at the other stake, then you are only 2" out of level.

## Parts list & Specs.

### OVALS

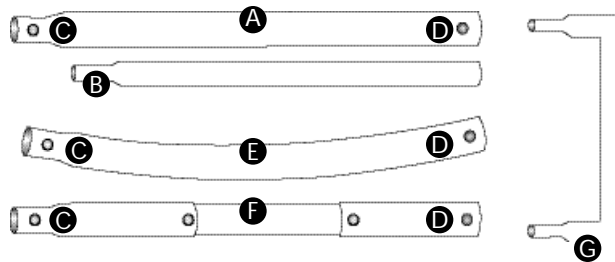

- A** TOP RAIL
- B** VERTICAL POLES
- C** LOCKING PIN
- D** LOCKING PIN Opening
- E** CURVED TOP RAIL
- F** F.L.R.
- G** U-PIPE

SIZE	TOP RAIL Round Pipe	VERTICAL POLES Stand Pipe	U-PIPES Bottom Pipe	F.L.R Final Locking Rail
10 X 19	13	28	14	1
14 X 23	13	28	14	1
14 X 27	15	32	16	1

### CIRCLES

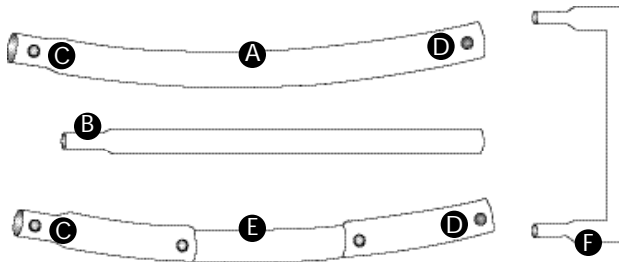

- A** TOP RAIL
- B** VERTICAL POLES
- C** LOCKING PIN
- D** LOCKING PIN Opening
- E** F.L.R.
- F** U-PIPE

SIZE	TOP RAIL Round Pipe	VERTICAL POLES Stand Pipe	U-PIPES Bottom Pipe	F.L.R Final Locking Rail
17'	13	28	14	1
21'	17	36	18	1

### RECTANGLES

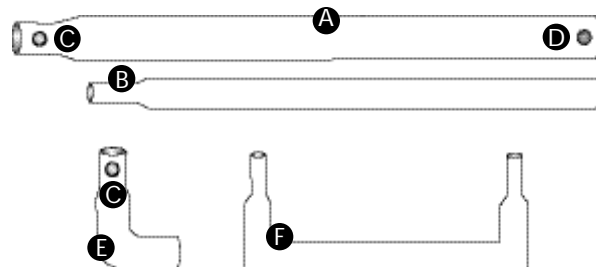

- A** TOP RAIL
- B** VERTICAL POLES
- C** LOCKING PIN
- D** LOCKING PIN Opening
- E** CORNER PIPE
- F** U-PIPE

SIZE	TOP RAIL Round Pipe	VERTICAL POLES Stand Pipe	U-PIPES Bottom Pipe	CORNER RAIL
9 X 17	12	24	12	4
13 X 21	16	32	16	4
13 X 25	18	36	18	4
17 X 29	22	44	22	4

## Legacy Ovals

- STEP 1 : Locate the area most suited for setting up the pool. Clear the area of any sharp objects or debris.
- STEP 2: Remove liner from carton marked "**LINER**," and place it in the center of where you plan to set up the pool. Be careful not to damage the liner when opening the box.
- STEP 3: Unfold the liner. Note where the pump and filter system will be connected. Position the two circular openings marked "**OUTLET**" and "**INLET**" for easy connection to the pump and filter.
- STEP 4: Remove framework from carton marked "**Framework**," and separate into three categories.  
 • **Top Rails** (Curved and Straight, 1 Straight Rail will be Adjustable) • **Vertical Poles** • **U-Pipes**
- STEP 5: Locate the **Flap Panel** on the liner. This is where you will find your serial number. This is also where the **Adjustable Top Rail** will be located.
- STEP 6: **Installing U-Pipes:** Slip the **U-Pipe** through the **U-Pipe Flaps** located around the base perimeter of the pool. Center the **U-Pipe** on **U-Pipe Flap** and extend flap outward. (See figure 1)

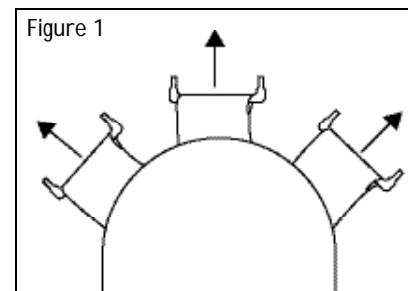

- STEP 7: **Installing Top Rails:** It is recommended to lay out the **Top Rails** (both curved and straight) along the perimeter of the pool. (See figure 2) This will help with the location of each **Top Rail**. There are a series of openings (1 large / 2 small) around the top perimeter of the pool liner. The small openings are to accommodate the **Vertical Poles**. The larger openings are to insert and center the **Top Rails**. Starting from either side of the **Flap Panel** start inserting the **Top Rails** through the large openings around the top perimeter of the pool. Connect the **Top Rails** (1 to 2, 2 to 3 & so on) using the locking pins to join one **Top Rail** to another. Make sure that all pins and holes are facing **downward** before inserting through the liner openings. As you connect the **Top Rails**, make sure the connection is centered on the large liner opening. Continue to connect all **Top Rails** until you reach back to the **Flap Panel**

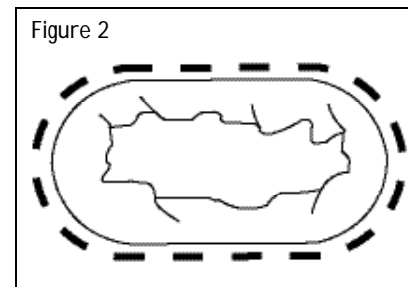

- STEP 8: **Installing the Final Locking Rail:** The last **Top Rail** to install will be the **Final Locking Rail (F.L.R.)**. Pushing in one of the locking pins (on the F.L.R.) will allow you to condense the F.L.R. (See figure 3) While condensed, insert the F.L.R. through the **Flap Panel**, and connect to the **Top Rails** to the left and right. Leave the F.L.R. condensed until the vertical poles have been installed.

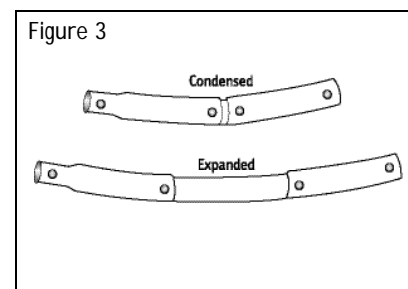

- STEP 9: **Installing Vertical Poles:** Place two **Vertical Poles** next to each **U-Pipe**. Connect all **Vertical Poles** to **U-Pipes** (slip fit); lay flat on ground, facing away from center of pool. Holding the outer end of a **Vertical Pole** lift. The **U-Pipe** will simply rotate as you lift the **Vertical Pole**. Lift the **Top Rail**, and slip the **Vertical Pole** through the smaller holes in the liner and into the **Top Rail**. Continue this process around the pool until all **Vertical Poles** are set in the **Top Rail**.

Tip: The two **Vertical Poles** setting into the **Final Locking Rail** will take some effort, as the F.L.R. is not yet extended.

- STEP 10: **Extending the F.L.R.:** Simply hold the **Vertical Pole** on either side of the F.L.R., and pull away from each other. This will extend the F.L.R. to its fullest position. The locking pins should snap into place automatically at full extension.

Tip: It is easier to extend the F.L.R. by holding the **Vertical Poles** near the top.

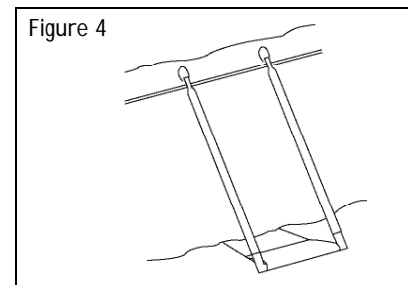

## Legacy Circles

- STEP 1: Locate the area most suited for setting up the pool. Clear the area of any sharp objects or debris.
- STEP 2: Remove liner from carton marked "**LINER**" and place it in the center of where you plan to set up the pool. Be careful not to damage the liner when opening the box.
- STEP 3: Unfold the liner. Note where the pump and filter system will be connected. Position the two circular openings marked "**OUTLET**" and "**INLET**" for easy connection to the pump and filter.
- STEP 4: Remove framework from carton marked "**Framework**" and separate into three categories.  
 • **Top Rail** (1 top rail will be **Adjustable**) • **Vertical Poles** • **U-Pipes**
- STEP 5: Locate the **Flap Panel** on the liner. This is where you will find your serial number. This is also where the **Adjustable Top Rail** will be located.
- STEP 6: **Installing U-Pipes:** Slip the **U-Pipe** through the **U-Pipe Flaps** located around the base perimeter of the pool. Center the **U-Pipe** on **U-Pipe Flap** and extend flap outward. (See figure 1)

- STEP 7: **Installing Top Rails:** It is recommended to lay out the **Top Rails** along the perimeter of the pool. (See figure 2) This will help with the location of each **Top Rail**. There are a series of openings (1 large / 2 small) around the top perimeter of the pool liner. The small openings are to accommodate the **Vertical Poles**. The larger openings are to insert and center the **Top Rails**. Starting from either side of the **Flap Panel** start inserting the **Top Rails** through the large openings around the top perimeter of the pool. Connect the **Top Rails** (1 to 2, 2 to 3 & so on) using the locking pins to join one **Top Rail** to another. Make sure that all pins and holes are facing **downward** before inserting through the liner opening. As you connect the **Top Rails**, make sure the connection is centered on the large liner opening. Continue to connect all **Top Rails** until you reach back to the **Flap Panel**.

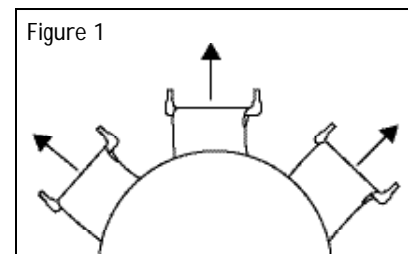

- STEP 8: **Installing the Final Locking Rail:** The last **Top Rail** to install will be the **Final Locking Rail (F.L.R.)**. Pushing in one of the locking pins (on the F.L.R.) will allow you to condense the **F.L.R.** (See figure 3). While condensed, insert the **F.L.R.** through the **Flap Panel** and connect to the **Top Rails** to the left and right. Leave the **F.L.R.** condensed until the vertical poles have been installed.

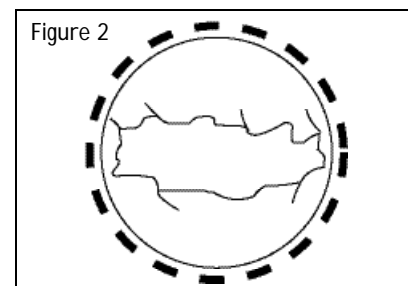

- STEP 9: **Installing Vertical Poles:** Place two **Vertical Poles** next to each **U-Pipe**. Connect all **Vertical Poles** to **U-Pipes** (slip fit); lay flat on ground, facing away from center of pool. Holding the outer end of a **Vertical Pole** lift. The **U-Pipe** will simply rotate as you lift the **Vertical Pole**. Lift the **Top Rail**, and slip the **Vertical Pole** through the smaller holes in the liner and into the **Top Rail**. (See figure 4) Continue this process around the pool until all **Vertical Poles** are set in the **Top Rail**.

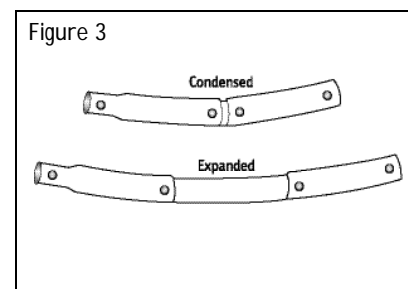

- Tip: The two **Vertical Poles** setting into the **Final Locking Rail** will take some effort, as the **F.L.R.** is not yet extended.

- STEP 10: **Extending the F.L.R.:** simply hold the **Vertical Pole** on either side of the **F.L.R.**, and pull away from each other. This will extend the **F.L.R.** to its fullest position. The locking pins should snap into place automatically at full extension.

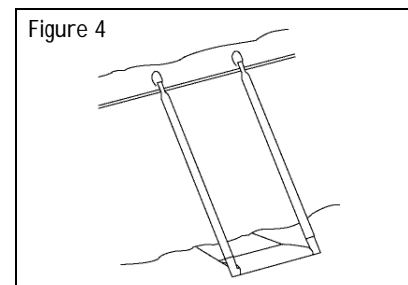

- Tip: It is easier to extend the **F.L.R.** by holding the **Vertical Poles** near the top.

## Legacy Rectangles

- STEP 1: Locate the area most suited for setting up the pool. Clear the area of any sharp objects or debris.
- STEP 2: Remove liner from carton marked "**LINER**" and place it in the center of where you plan to set up the pool. Be careful not to damage the liner when opening the box.
- STEP 3: Unfold the liner. Note where the pump and filter system will be connected. Position the two circular openings marked "**OUTLET**" and "**INLET**" for easy connection to the pump and filter.
- STEP 4: Remove framework from carton marked "**Framework**" and separate into three categories.  
• **Top Rails** (to include 4 corner pieces) • **Vertical Poles** • **U-Pipes**
- STEP 5: **Installing U-Pipes** Slip the **U-Pipes** through the **U-Pipe Flaps** located around the base perimeter of the pool. Center the **U-Pipe** on **U-Pipe Flap** and extend flap **outward**. (See figure 1)
- STEP 6: **Installing Top Rails:** It is recommended to layout the **Top Rails** along the perimeter of the pool. (See figure 2) This will help with the location of each **Top Rail**. At each corner of the pool the liner is opened to insert the **Top Rails**. It is recommended to connect the **Top Rails** for each side (4) independently, and insert through liner opening as one piece. Make sure all pins and holes are facing downward before inserting through the liner opening. Now connect the **Corner Rails** to the assembled **Top Rails**.
- Tip: To make the last connection of the fourth **Corner Rail** have one person at the other end of the last **Top Rail** to be connected, hold the (already connected) **Corner Rail** and pull. This will allow for a much easier connection of the fourth and last **Corner Rail** (See figure 3)
- STEP 7: **Installing Vertical Poles** Place two **Vertical Poles** next to each **U-Pipe**. Connect all **Vertical Poles** to **U-Pipes** (slip fit); lay flat on ground, facing away from center of pool. Holding the outer end of a **Vertical Pole** lift. The **U-Pipe** will simply rotate as you lift the **Vertical Pole**. Lift the **Top Rail**, and slip the **Vertical Pole** through the smaller holes in the liner and into the **Top Rail**. (See figure 4) Continue this process around the pool until all **Vertical Poles** are set in the **Top Rail**.

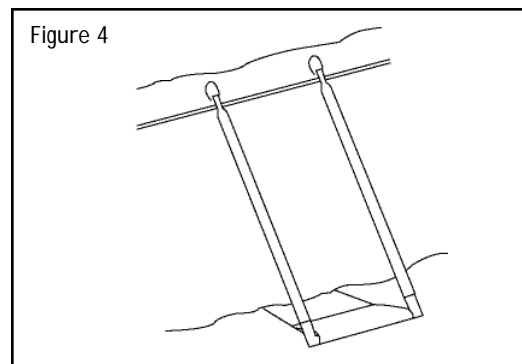
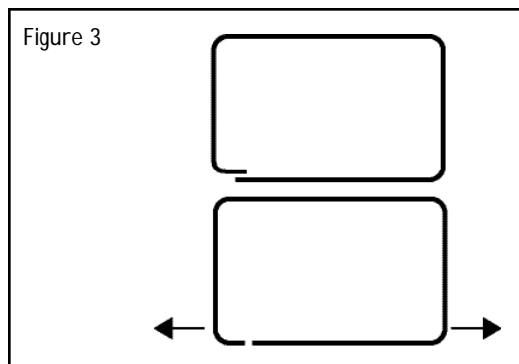
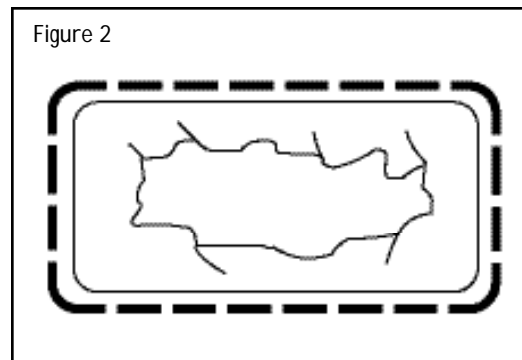
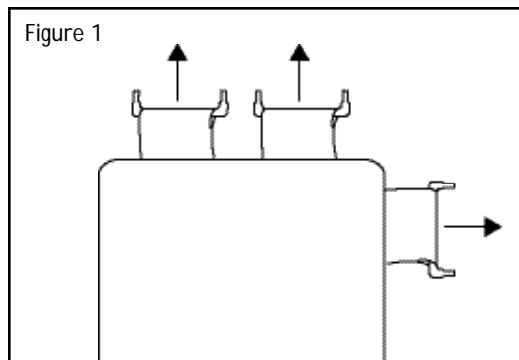



Legacy<sup>®</sup>  
POOLS

**Portable Pools Inc.,  
Corporate Headquarters**

**Tel : 949-494-6107**

**Fax : 949-494-4804**

2825 Laguna Canyon Road  
Laguna Beach, CA92652

website: [www.legacypools.com](http://www.legacypools.com)

email: [info@legacypools.com](mailto:info@legacypools.com)